



**HENRY PARK PRIMARY SCHOOL
END OF THE YEAR EXAMINATION 2021**

PRIMARY 5

SCIENCE

SECTION A (56 MARKS)

INSTRUCTIONS TO CANDIDATES

1. Do not turn over this page until you are told to do so.
2. Follow all instructions carefully.
3. Answer all questions.
4. Shade your answers on the Optical Answer Sheet (OAS) provided.

Name: _____ ()

Class: Primary 5 ()

Date: 27 October 2021

Total Time for Booklets A and B: 1 h 45 min

Sections	Marks
A	/ 56
B	/ 44
Total	/ 100

Parent's Signature: _____

Booklet A (56 marks)

For each question from 1 to 28, four options are given. One of them is the correct answer. Make your choice (1, 2, 3 or 4). Shade the correct oval (1, 2, 3 or 4) on the **Optical Answer Sheet**

1. The picture shows animal R.



Animal R

The diagram shows a classification chart.

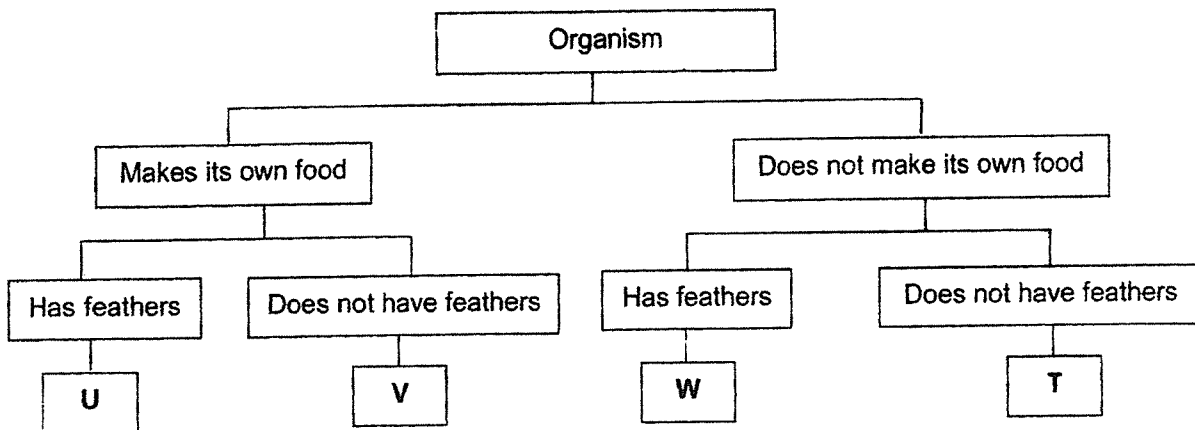

Based on the information given, which organism best represents animal R?

- (1) U
- (2) V
- (3) W
- (4) T

()

2. A lizard detaches and drops its tail when attacked.
Which characteristic of living things does this show?

- (1) Living things grow.
- (2) Living things reproduce.
- (3) Living things respond to changes.
- (4) Living things need air, food and water.

()

3. The diagram shows two types of cells, M and N.

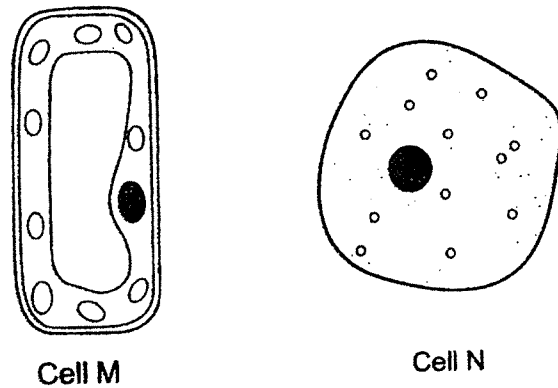

Lisa made the following statements to compare the cells shown above.

- A Both cells have some common parts.
- B Both cells contain genetic information.
- C Both cells belong to the same organism.

Which of the above statements are correct?

- (1) A and B only
- (2) A and C only
- (3) B and C only
- (4) A, B and C

()

4. The diagrams show the male and female reproductive systems in humans.

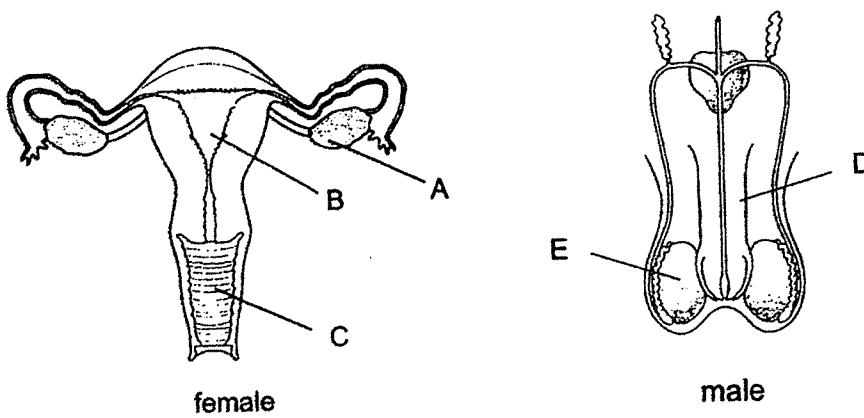

Which one of the following is correct?

	Where egg is produced	Where fertilised egg develops	Where sperm is produced
(1)	A	C	E
(2)	E	B	A
(3)	A	B	E
(4)	E	C	A

()

5. The diagram shows the different parts of a flower.

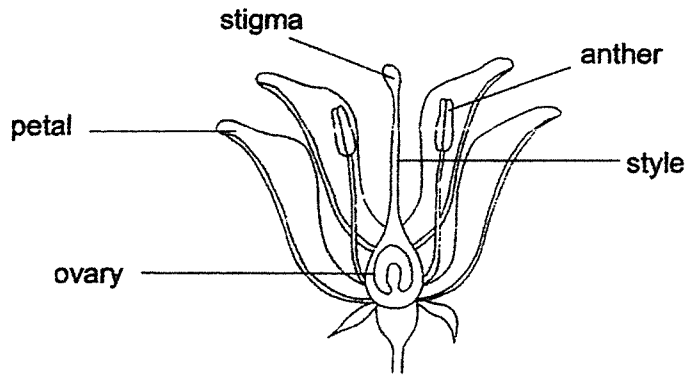

The black dots in the diagrams below represent pollen grains.

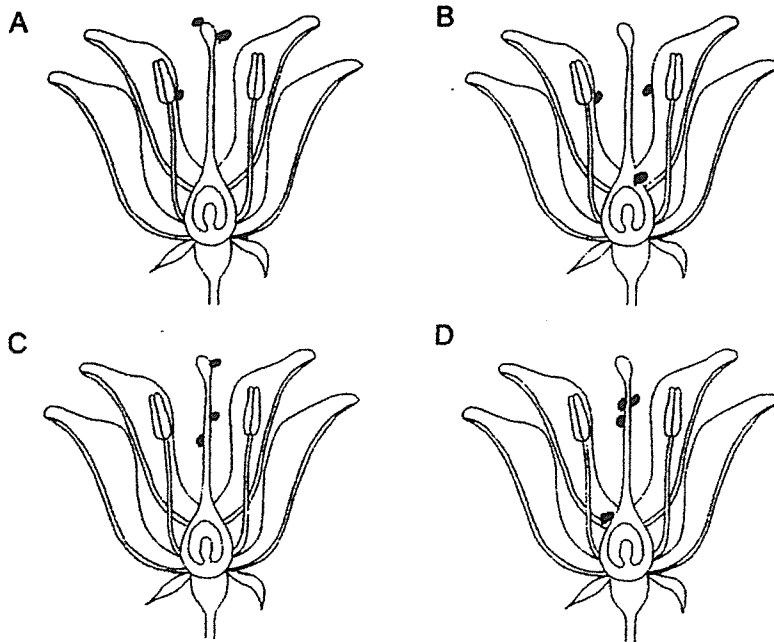

Which of the above flowers have been pollinated?

- (1) A and B only
- (2) A and C only
- (3) B and D only
- (4) C and D only

()

6. Compare the two fruits shown in the diagrams below.

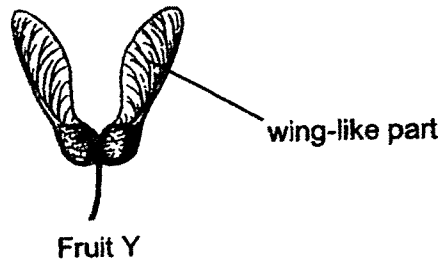
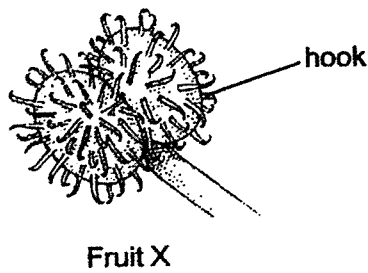

Which of the following statement(s) is/are correct?

- A Fruit Y is dispersed by wind.
- B Both fruits have fleshy edible parts.
- C Fruit X clings onto the body covering of animals.

- (1) B only
- (2) C only
- (3) A and B only
- (4) A and C only

()

7. The diagram below shows a plant in a pot with wet soil.

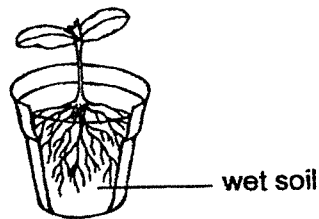

Which of the following statement(s) is / are correct?

- A The roots help the plant to hold onto the soil.
- B The roots help to take in water and minerals.
- C The roots make food for the plant.

- (1) B only
- (2) A and B only
- (3) B and C only
- (4) A and C only

()

8. Kayden learnt about the following in school:

- Bees and butterflies are pollinators.
- Butterflies have good vision but a poor sense of smell.
- Bees have a good sense of smell. Bees are able to see the colours, blue and yellow, but **not** red.

Kayden found three different plants, X, Y and Z, in the garden and made the following observations:

Plant	Observations
X	Flowers are bright red. Many bees are seen flying around the plant.
Y	Flowers have huge, red petals. Many butterflies are seen fluttering around the plant.
Z	Both bees and butterflies are found around the plant.

Based on the information given, what can he conclude about plants X, Y and Z?

- A Flowers on plant Y do not have a sweet-smelling scent.
 B Flowers on plant Z have large, red petals.
 C Flowers on plant X have a sweet-smelling scent.

- (1) A and B only
 (2) B and C only
 (3) A and C only
 (4) A, B and C

()

9. Four seeds, A, B, C and D, are sown under different conditions as shown in the table below. A (✓) tick represents the presence of the condition(s).

Seed	Condition			
	Sunlight	Air	Warmth	Water
A	✓	✓	✓	X
B	✓	X	X	✓
C	✓	X	✓	✓
D	X	✓	✓	✓

Which seed is most likely to germinate?

- (1) A
 (2) B
 (3) C
 (4) D

()

10. Which one of the following groups of animals has a 4-stage lifecycle?

	Group	Animals
(1)	A	mosquito, beetle and butterfly
(2)	B	cockroach, mosquito and butterfly
(3)	C	mosquito, grasshopper and beetle
(4)	D	grasshopper, cockroach and beetle

()

11. The diagram shows a flowering plant.

Which part, (1), (2), (3) or (4), helps the plant to grow straight up to obtain sunlight?

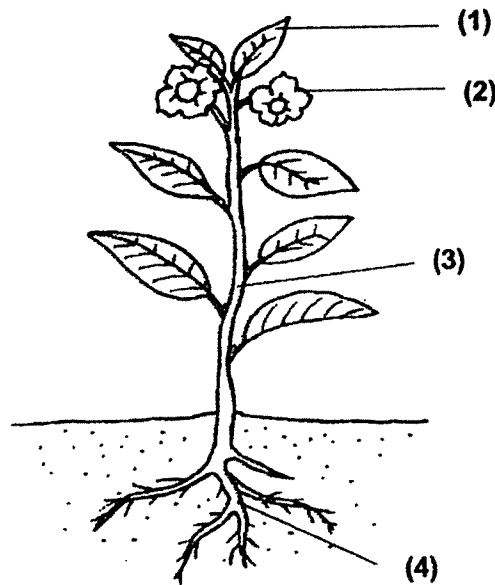

()

12. Study the classification table given below carefully. M and N represent common characteristics observed among three types of animals. A (✓) tick represents the presence of the characteristic.

Animals	Common characteristics	
	M	N
Fish	✓	✓
Reptiles	✓	✓
Amphibians		✓

Which of the following best represents the headings M and N?

	M	N
(1)	Lay eggs	Have scales
(2)	Lay eggs	Live in the water
(3)	Have scales	Have gills
(4)	Have scales	Lays eggs

()

13. The diagram shows part of the human digestive system.

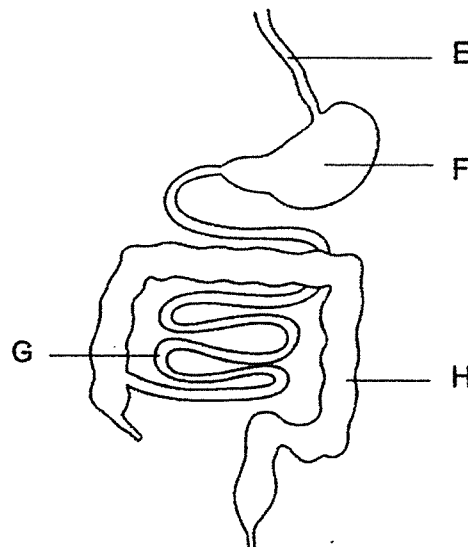

Based on the diagram given above, which of the following is correct?

	where digestion does not occur	where digested food is absorbed	where water is absorbed
(1)	E and G	H	G
(2)	F and G	G	H
(3)	H only	H	G
(4)	E and H	G	H

()

14. Study the classification chart below.

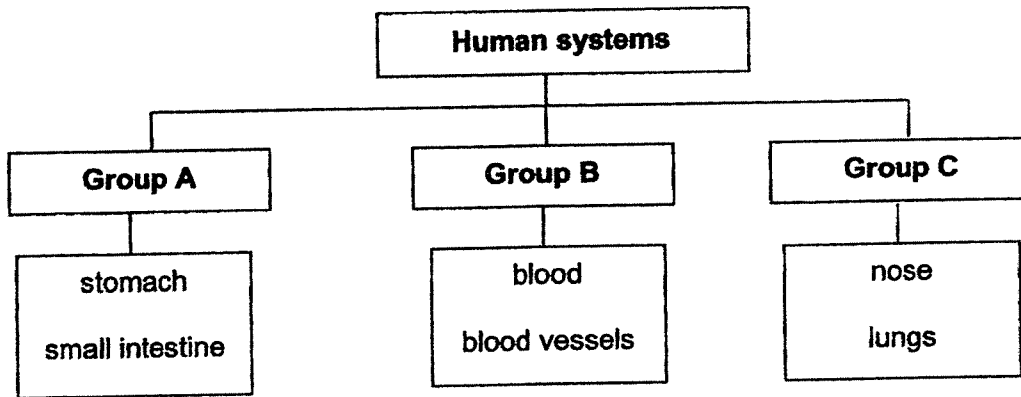

In which group should the windpipe be placed under?

- (1) Group A
- (2) Group B
- (3) Group C
- (4) None of the above

()

15. The picture shows two bumper cars at an amusement park. Players bump their cars at part W.

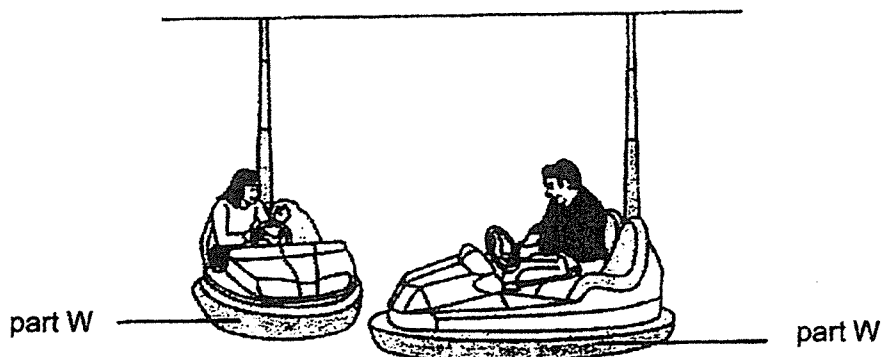

Which of the following gives a property of the material used to make part W and explains why it is suitable?

	Property	Explanation
(1)	magnetic	W can attract each other.
(2)	flexible	W breaks easily when bent.
(3)	strong	W will not break easily when hit.
(4)	waterproof	W will not get wet easily.

()

16. A beaker contained three powders F, G and H mixed together. These powders cannot be dissolved in water. The properties of the three powders are given in the table below.

Powder	Is it a magnetic material?	Is it a conductor of electricity?	Does it float in water?
F	No	Yes	No
G	No	No	Yes
H	Yes	Yes	No

Which of the following steps can be used to separate the three powders?

- A Adding water
- B Adding a battery
- C Using a magnet

- (1) A only
- (2) A and C only
- (3) B and C only
- (4) A, B and C

()

17. The melting point of substance R is 115°C . Its boiling point is 444°C .

Which of the following correctly describe the properties of substance R at 120°C ?

- A It has a fixed shape.
- B It has no definite volume.
- C It cannot be compressed.
- D It does not have a fixed shape.

- (1) A and B only
- (2) A and C only
- (3) B and D only
- (4) C and D only

()

18. Zara conducted an experiment using a beaker of warm water. She measured the temperature of the water, at various times, throughout the experiment. The changes in the temperature are shown in the graph below.

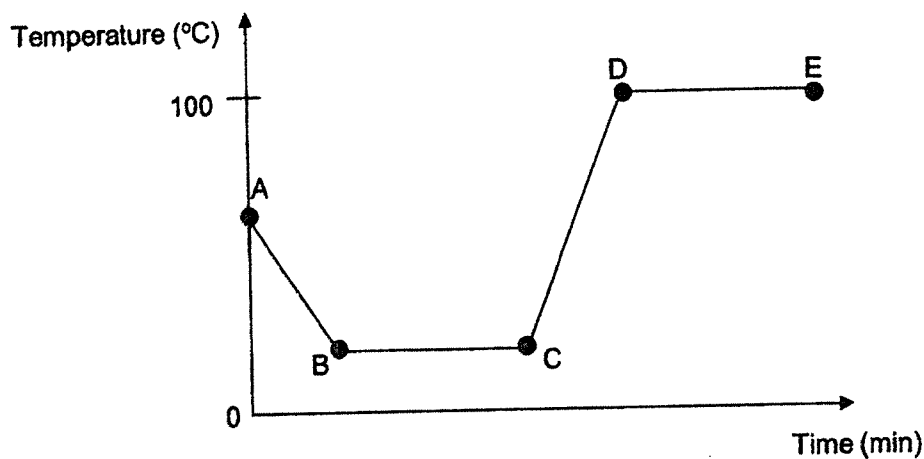

Which one of the following correctly describes the changes taking place in the beaker of water during the experiment?

	Points	Change in state of water	Heat gain or lost by water
(1)	A to B	No	Gain
(2)	B to C	No	Lost
(3)	C to D	Yes	Lost
(4)	D to E	Yes	Gain

()

19. Joseph placed some ice cubes into a trough of water at room temperature.

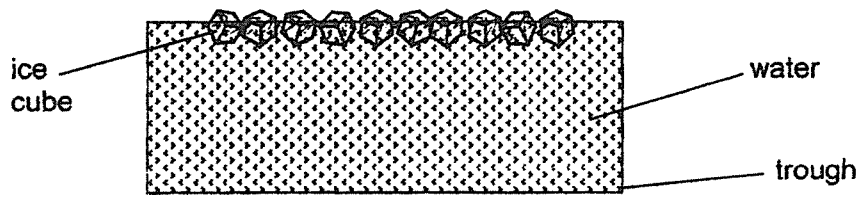

What is likely to happen after 20 minutes?

- A The water in the trough would freeze.
- B The ice cubes would be melting.
- C The temperature of the water would decrease.
- D The amount of water in the trough would decrease.

- (1) A and D only
- (2) B and C only
- (3) A, C and D only
- (4) A, B, C and D

()

20. The diagrams show a kettle with boiling water and the natural water cycle.

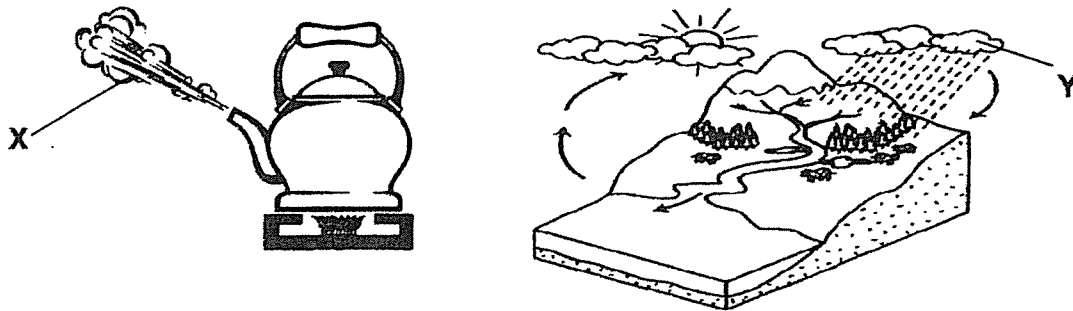

Which of the following statements are correct?

- A X and Y are made up of water vapour.
- B X and Y are made up of water droplets.
- C X was formed as a result of condensation.
- D Y was formed as a result of condensation.

- (1) A and D only
- (2) B and C only
- (3) B, C and D only
- (4) A, C and D only

()

21. The diagram shows an electrical circuit. All the batteries and light bulbs are identical and working.

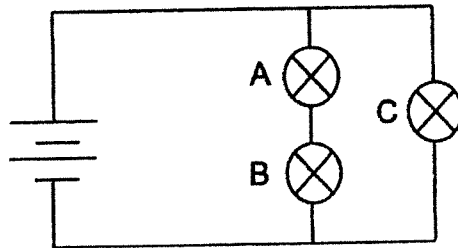

Which of the following observations will be made if bulb B fuses?

- (1) Bulb A becomes dimmer.
- (2) Bulb C becomes brighter.
- (3) Bulbs A and C do not light up.
- (4) Brightness of bulb C remains unchanged.

()

22. The diagram shows a circuit with 2 rods, X and Y, dipped in liquid Z. The bulb lights up when the switch is closed.

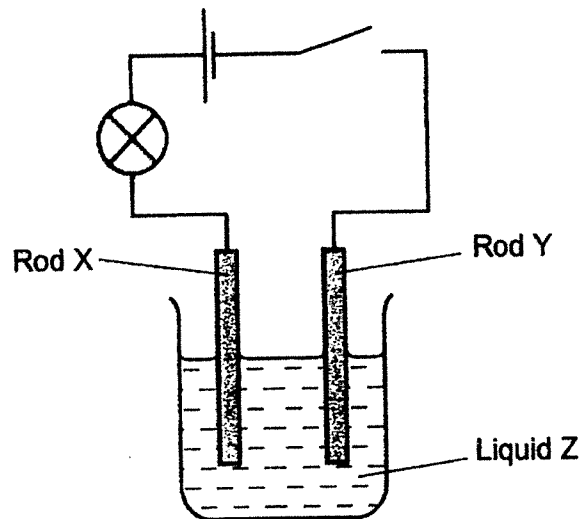

Which of the following correctly identifies Rod X, Rod Y and Liquid Z?

	Rod X	Rod Y	Liquid Z
(1)	metal	plastic	conductor of electricity
(2)	metal	metal	conductor of electricity
(3)	plastic	metal	non-conductor of electricity
(4)	plastic	plastic	non-conductor of electricity

()

23. The diagram shows a circuit with three switches and four light bulbs. Jude closed all the three switches and all the four light bulbs lit up.

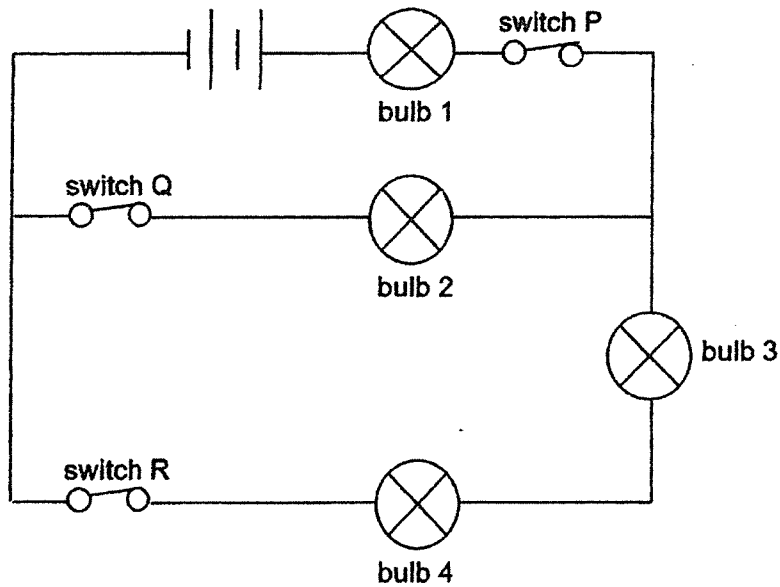

Which switch(es) can be opened without affecting the brightness of bulb 2?

- (1) P only
 (2) Q only
 (3) R only
 (4) P and R only

()

24. Three rings, P, Q and R, made of different metals are fitted together, as shown in the diagram below. The rings are of different sizes. Ring R fits into ring Q and ring Q fits into ring P.

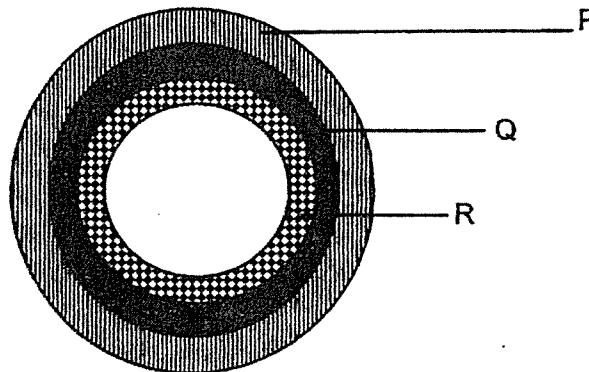

All three rings were then heated to 60°C. Ring R falls out of ring Q easily but ring Q still stay fitted in ring P.

Which of the following best explains why the above happened?

- (1) Ring P does not expand when heated.
 (2) Ring Q expands more than ring R when heated.
 (3) Ring R expands more than ring Q when heated.
 (4) Rings P, Q and R expand and contract when heated.

()

25. Three bar magnets AB, CD and EF and an iron bar GH are set up as shown in the arrangement below.

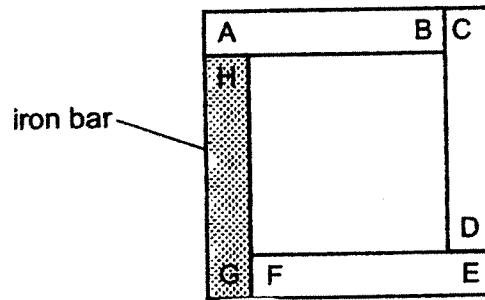

Which one of the following diagrams shows a possible arrangement?

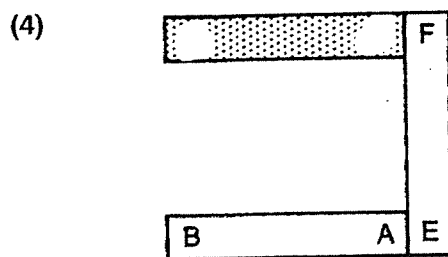
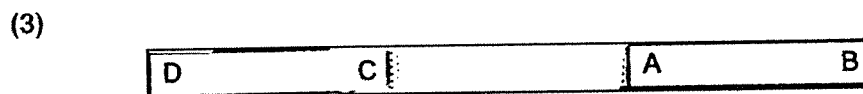
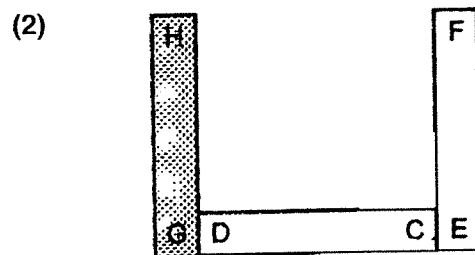
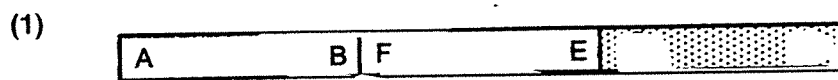

()

26. The set-up shown below is used to attract iron pins.

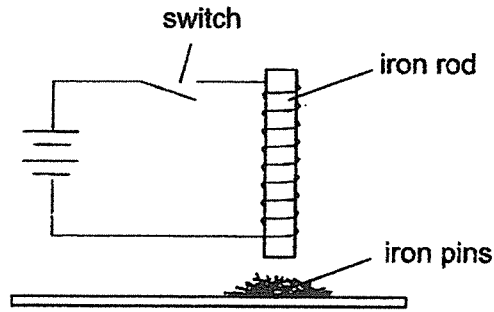

Based on the set-up shown above, three students made the following predictions.

- Anne: More pins will be attracted if the iron rod is placed further away from the iron pins.
- Brian: More coils of wire around the iron rod will increase the number of iron pins attracted.
- Cody: Removing one battery from the set-up will decrease the number of iron pins attracted.

Which student(s) is/are correct?

- (1) Anne only
- (2) Cody only
- (3) Anne and Brian only
- (4) Brian and Cody only

()

27. The diagram shows a glass of lemonade.

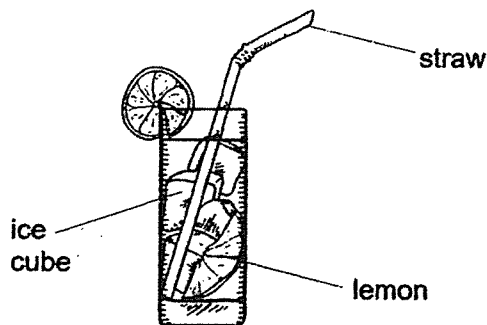

Three children, Andy, Ben and Chris, made the following statements.

- Andy: The ice cubes gain heat from the glass.
- Ben: The lemonade gains heat from the ice cubes.
- Chris: The straw loses heat to the ice cubes.

Whose statements is/are correct?

- (1) Andy only
- (2) Andy and Chris only
- (3) Ben and Chris only
- (4) Andy, Ben and Chris

()

28. While walking past a street lamp one night, Muthu noticed the length of his shadow change when he was at different locations as shown below.

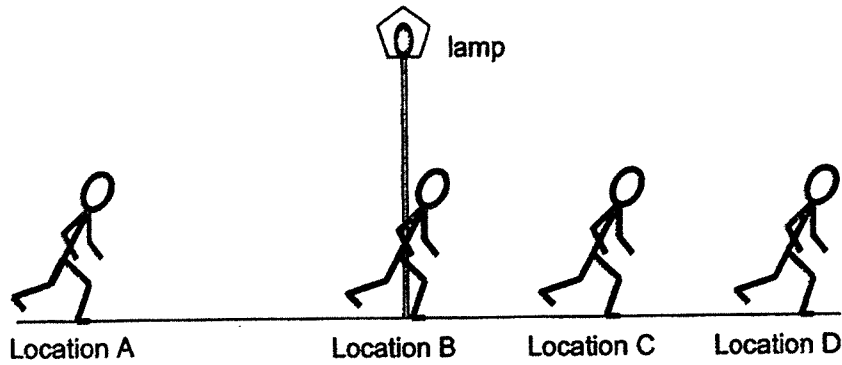

Which one of the following graphs shows correctly the length of his shadow in at different locations?

(1)

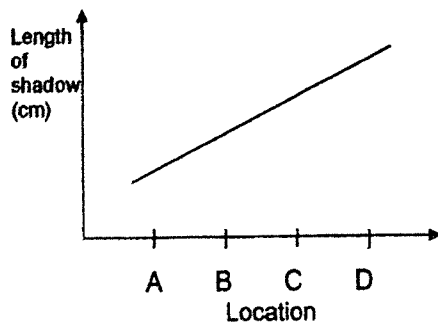

(2)

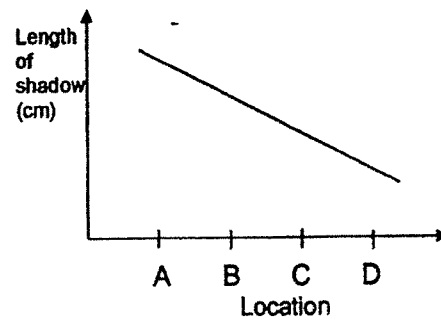

(3)

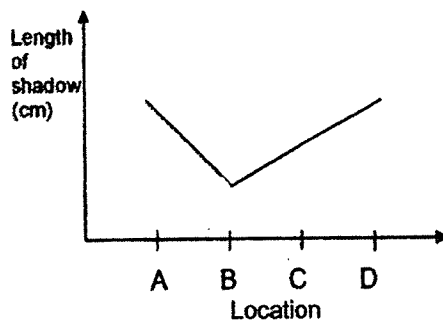

(4)

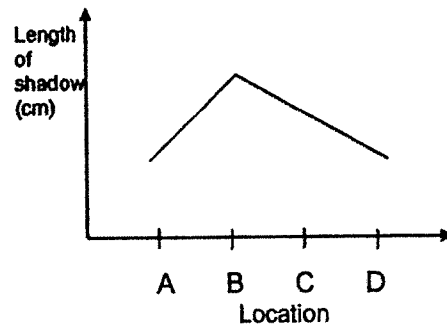

()

End of Booklet A

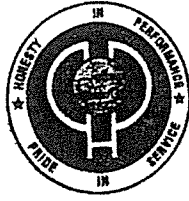

HENRY PARK PRIMARY SCHOOL
END OF THE YEAR EXAMINATION 2021
PRIMARY 5
SCIENCE
SECTION B (44 MARKS)

INSTRUCTIONS TO CANDIDATES

1. Do not turn over this page until you are told to do so.
2. Follow all instructions carefully.
3. Answer all questions.

Name: _____ ()

Class: Primary 5 ()

Date: 27 October 2021

Total Time for Booklets A and B: 1 h 45 min

Marks for Section B: _____

Booklet B (44 marks)

Write your answers to questions 29 to 40 in the spaces given.

29. Max wanted to investigate the conditions needed for the growth of bread mould using four similar slices of bread, W, X, Y and Z. Each slice of bread was placed under conditions shown in table A.

Table A

Bread slice	Conditions		
	Temperature of surrounding air (°C)	Amount of water on bread slice (cm ³)	Number of days for mould to appear
W	30	0	-
X	5	5	9
Y	5	15	6
Z	30	15	4

- a) State which two slices of bread (W, X, Y and Z) should be compared to find out how changing the following variables would affect the growth of bread mould. [1]

Experiment	Variable changed	Slices of bread compared
1	Presence of water on the slice of bread	_____ and _____
2	Temperature of surrounding air	_____ and _____

- b) Name the group of living things bread mould belong to. [1]

- c) Using the information given in table A, explain whether water is needed for bread mould to grow. [1]

- d) Besides repeating the experiment, suggest another way Max can ensure that the results of his experiment are more reliable. [1]



30. The diagram shows some stages in the life cycle of flowering plants.

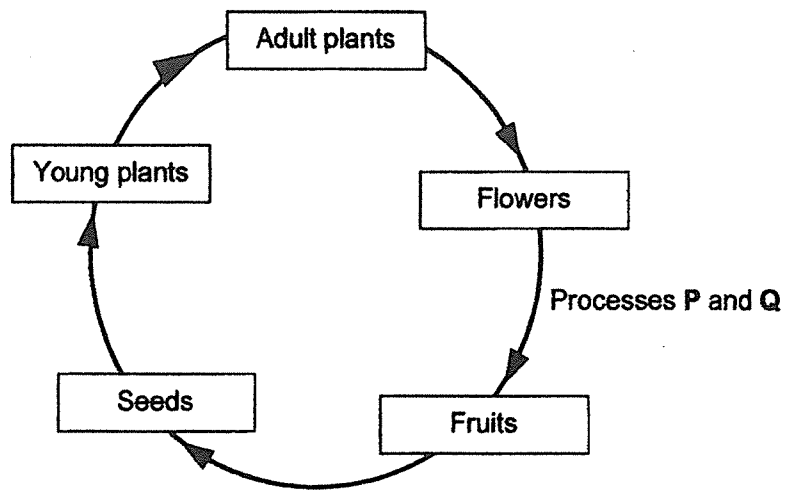

a) Fruits are produced only after processes P and Q take place. Process P takes place before process Q. [1]

Name processes P and Q.

Process P: _____ Process Q: _____

The diagram shows part of a flower Nathan observed in the school garden.

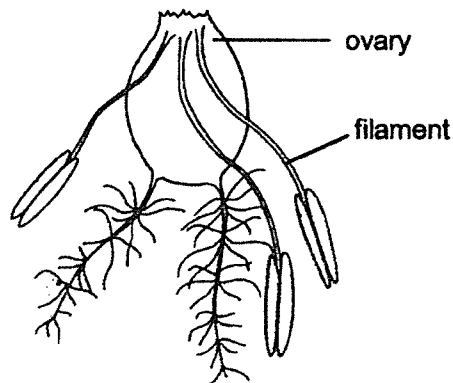

b) Nathan concluded that the flower is pollinated by wind. [2]
Using the diagram given, explain why he is correct.

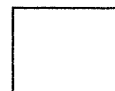

31. The diagram shows a leaf cell.

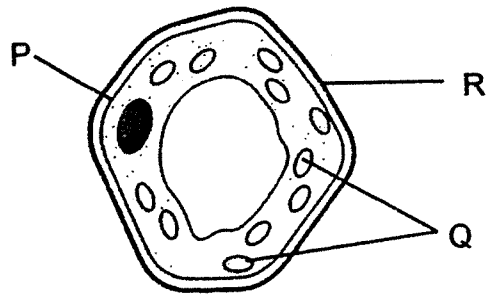

(a) Name parts Q and R.

[2]

Q - _____

R - _____

(b) State the function of part P.

[1]

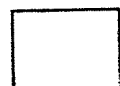

32. The graph shows how the speed of wind affects the distance between the young plants and their parent plants.

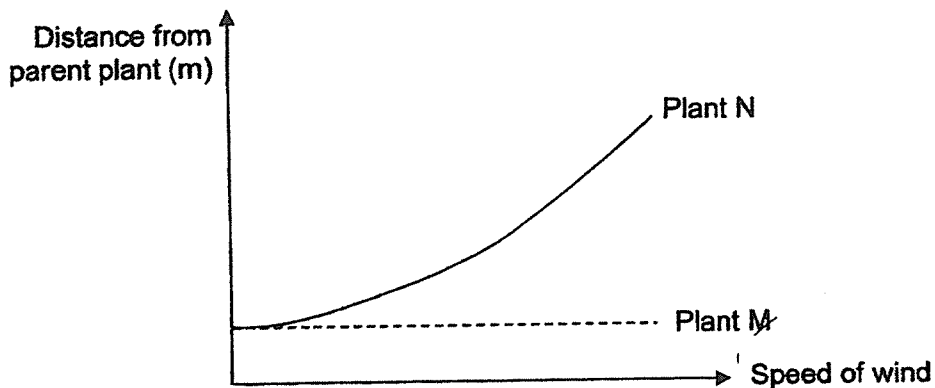

a) The diagrams below show two types of fruits.

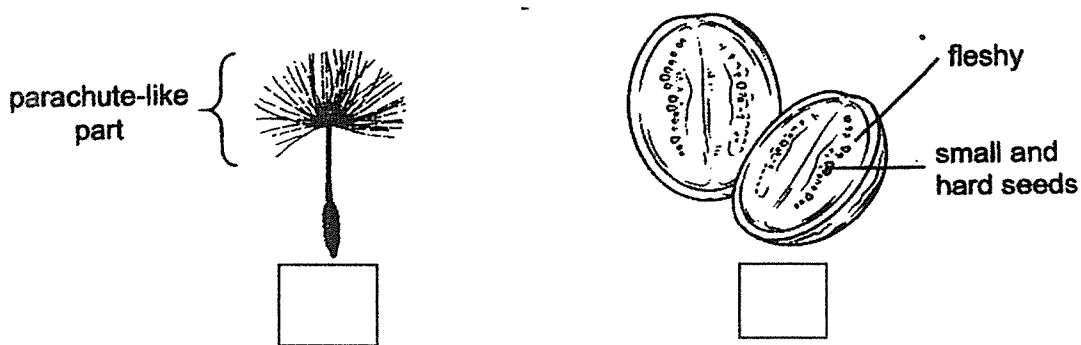

Which one of the fruits shown above is likely to be the fruit of plant N?
Put a tick (✓) in the correct box.

Using the information from the graph, explain your answer.

[2]



Question 32 continued

The diagram shows the distribution of plants J, K, L and M near a river.

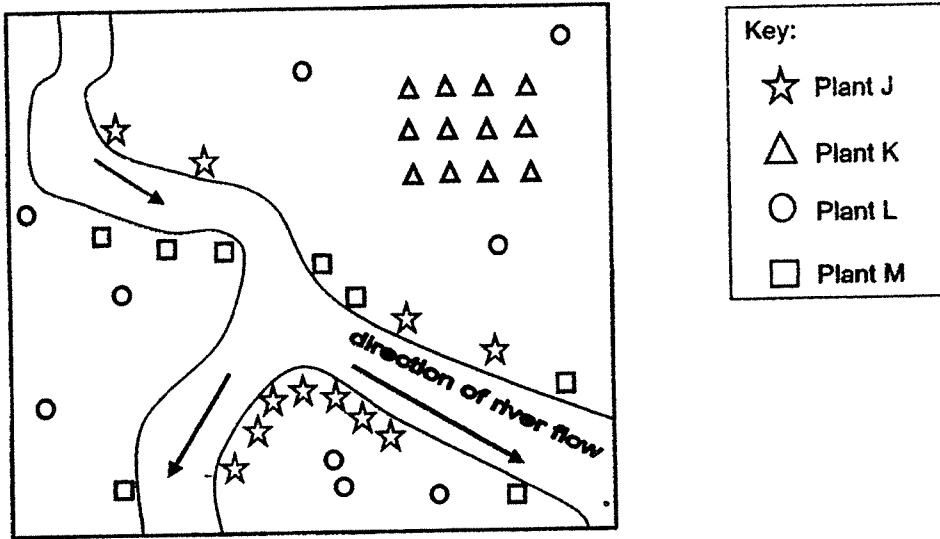

b) Classify plants L and M into the table below correctly. [1]

Plant	
Fruits/seeds are dispersed by water	Fruits/seeds are dispersed by animals

c) State a characteristic of the fruit of plant J and explain how this characteristic helps in the dispersal of its seeds. [2]



33. Dave conducted an experiment to find out which material could be used to make a pair of gloves that would keep his hands dry.

He dipped a strip of material P into a container of water as shown below.

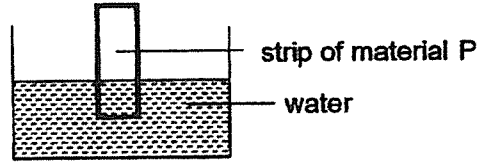

The volume of water in the container at the start was 200 cm^3 . The volume of water left in the container after P was removed was measured and recorded.

He repeated the steps using strips of materials Q, R and S and the results are shown in the table below.

Material	Volume of water left (cm^3)
P	180
Q	150
R	200
S	100

Which material, P, Q, R or S, is most suitable for making the gloves Dave wanted? [2]

Explain your answer.



34. A group of students measured the size of a puddle of water to see how length X changed over a period of time on a hot day.

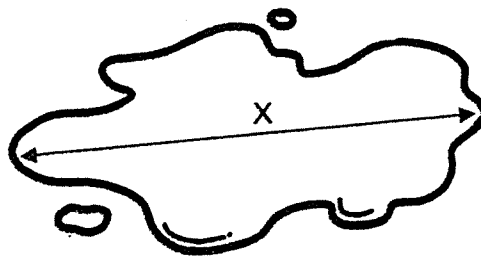

The students then drew a graph to show how the length of the puddle changed over a period of 4 hours.

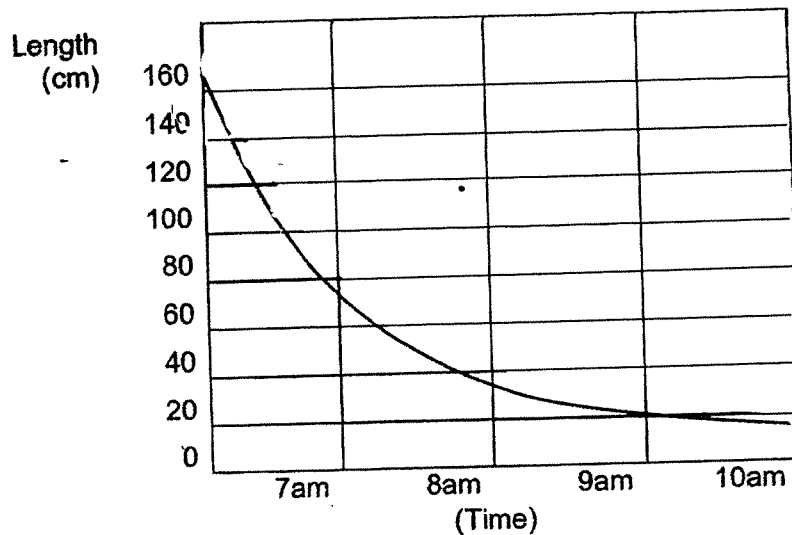

- a) What can the students conclude about the length of the puddle over time? Explain why it was observed. [2]

- b) Draw another line on the graph above to show how the length of the puddle would have changed during the same period on a cold day. [1]

- c) Explain your answer in (b). [1]

- d) What can be done to reduce the length of the puddle more quickly on a cold day? [1]

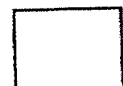

35. Two similar wooden balls, A and B, were placed at different distances in front of a screen as shown in the diagram below.

A light source was switched on and bright light was shone evenly on the 2 wooden balls. The shadows of the wooden balls were cast on the screen. The balls were not blocking each other.

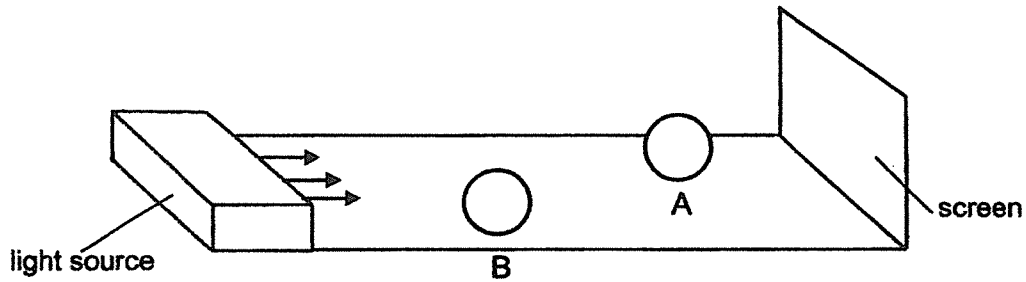

- a) In the box below, draw the shadows formed by balls A and B on the screen. [2]

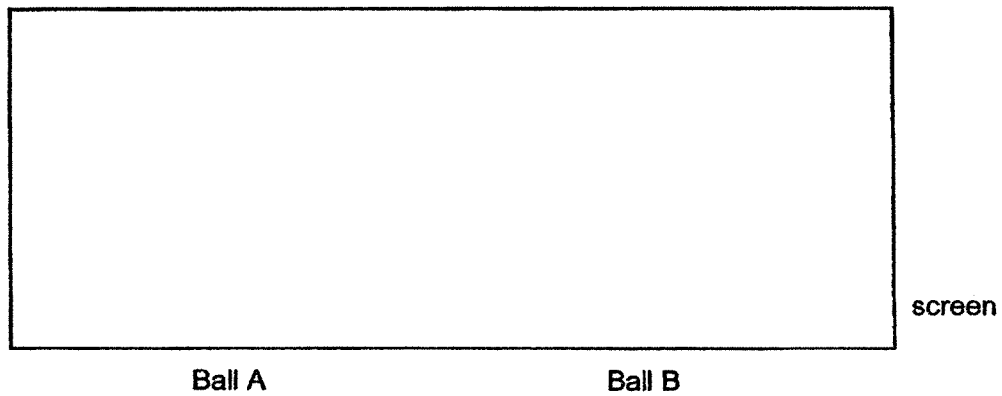

- b) Explain how shadows are formed. [1]

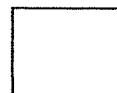

Question 35 continued

Shawn was driving his car along a road at night with no street lamps. Luckily, there were reflective strips placed along the road curve as shown below.

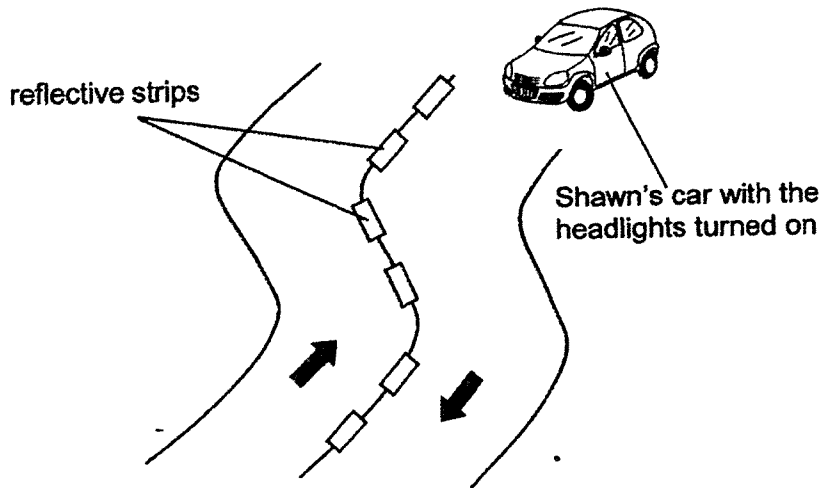

c) Explain how the reflective strips helped Shawn to drive safely at night. [2]

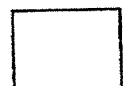

36. a) State what temperature is.

[1]

Nathan placed three identical ice cubes into three identical containers, P, Q and R, as shown in the diagrams below.

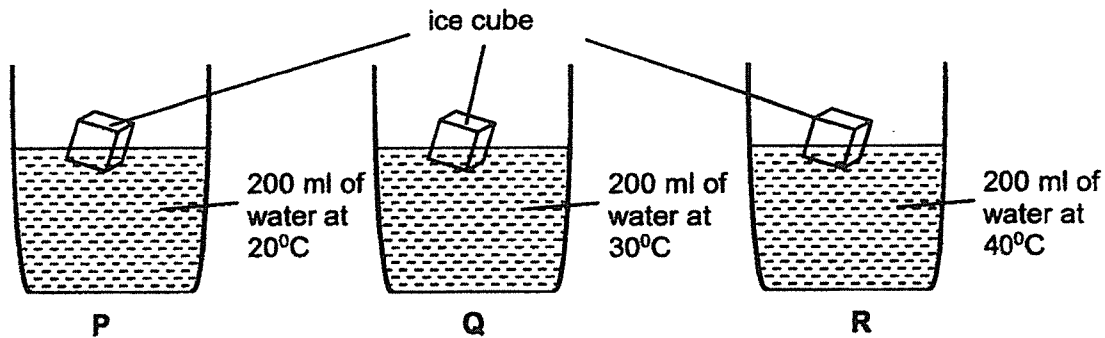

He recorded the time taken for the ice cubes to melt completely in each container.

b) What was Nathan trying to find out from his experiment?

[1]

c) Arrange the three containers, P, Q and R, in the boxes below according to the time taken for the ice cubes to melt. [1]

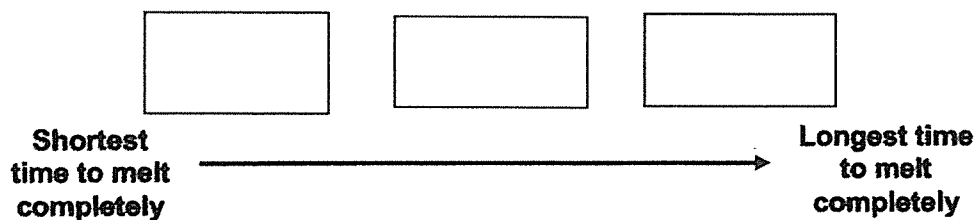

d) Nathan placed four uncooked eggs of similar sizes into two identical metal containers of boiling water.

He observed that the time taken for the eggs to be cooked is shorter when the volume of boiling water in the metal container is larger. Explain why.

[1]



37. Aminah put a bottle of *fizz drink* at 28°C on an electronic balance to measure its mass.

The *fizz drink* contained sugar, water, a gas and some food colouring. She removed the bottle cap, and the drink began to fizz (*produce gas bubbles and make a hissing sound*).

She left the open bottle of drink on the electronic balance for a few days in a room of temperature 30°C as shown below.

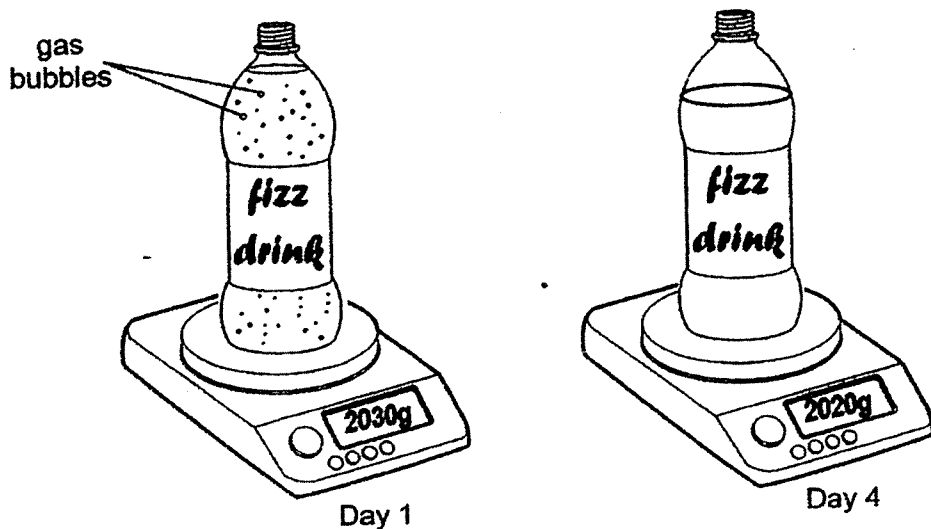

(a) A few days later the drink was no longer fizzy. [2]
Based on the diagrams given, state **two** changes that can be observed from the *fizz drink* a few days later.

- (i) _____

- (ii) _____

(b) Explain your answer in parts a (i) and a (ii). [2]

- (i) _____

- (ii) _____



38. Kumar carried out an experiment using the set-up shown below.

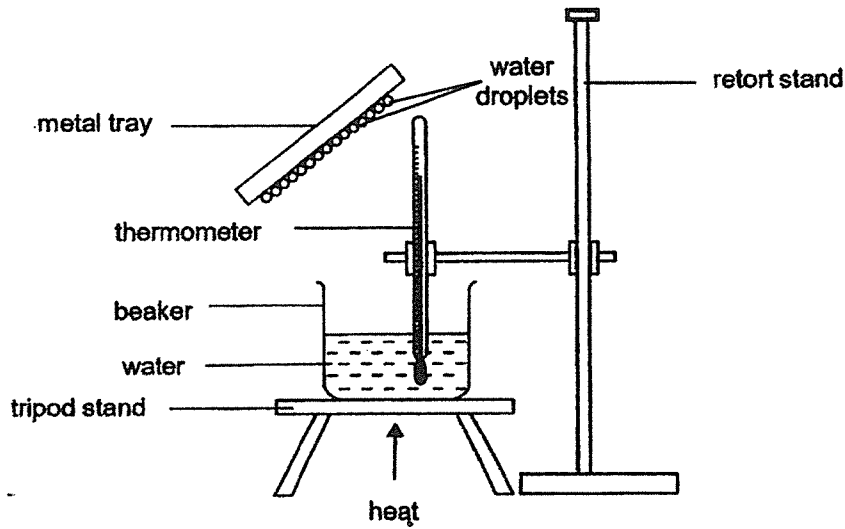

As the water started to boil, tiny water droplets were observed on the underside of the metal tray.

(a) State the temperature of the water when it was boiling. [1]

_____ °C

(b) Based on the information given, explain how the tiny water droplets were formed on the underside of the metal tray. [2]



39. Gene created a model of a traffic light using three bulbs (A, B and C), three switches (1, 2 and 3), two batteries and some wires.



In the box below, complete the circuit diagram that allows the traffic light to light up only **one** bulb at a time. [3]

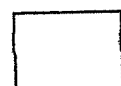
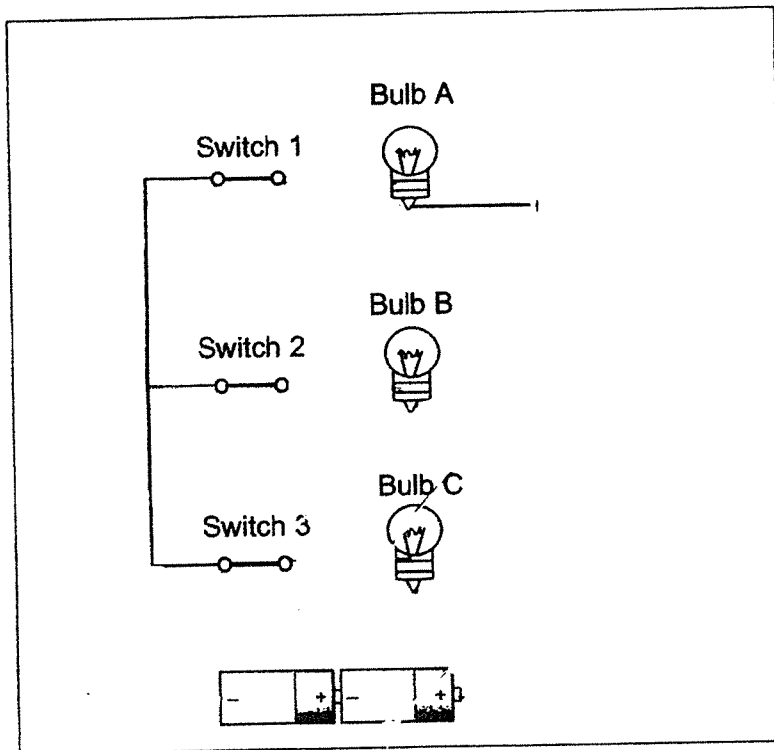

40. Identical bulbs and batteries are used to set up the circuit shown below.

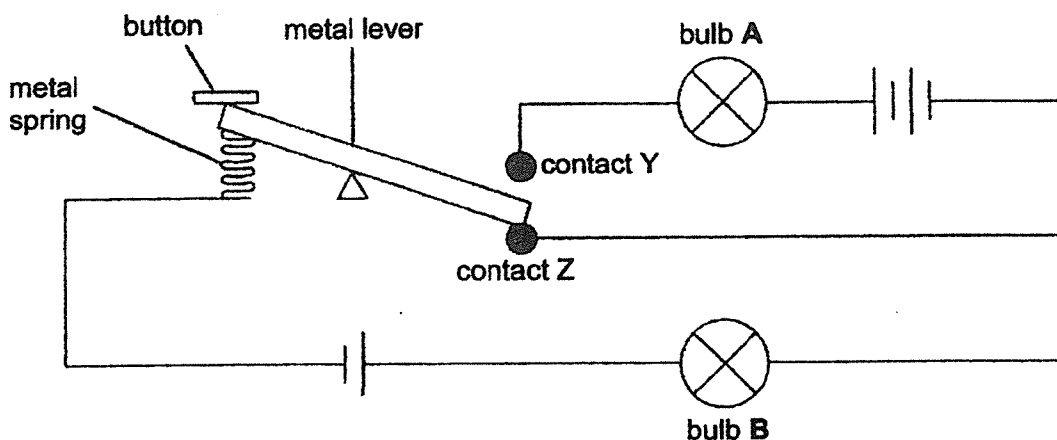

a) What happens to the brightness of bulb B when the button is pushed down? Explain your answer. [2]

b) State one property of the material used to make contacts Y and Z that allows the bulbs to light up. [1]

End of Booklet B

